

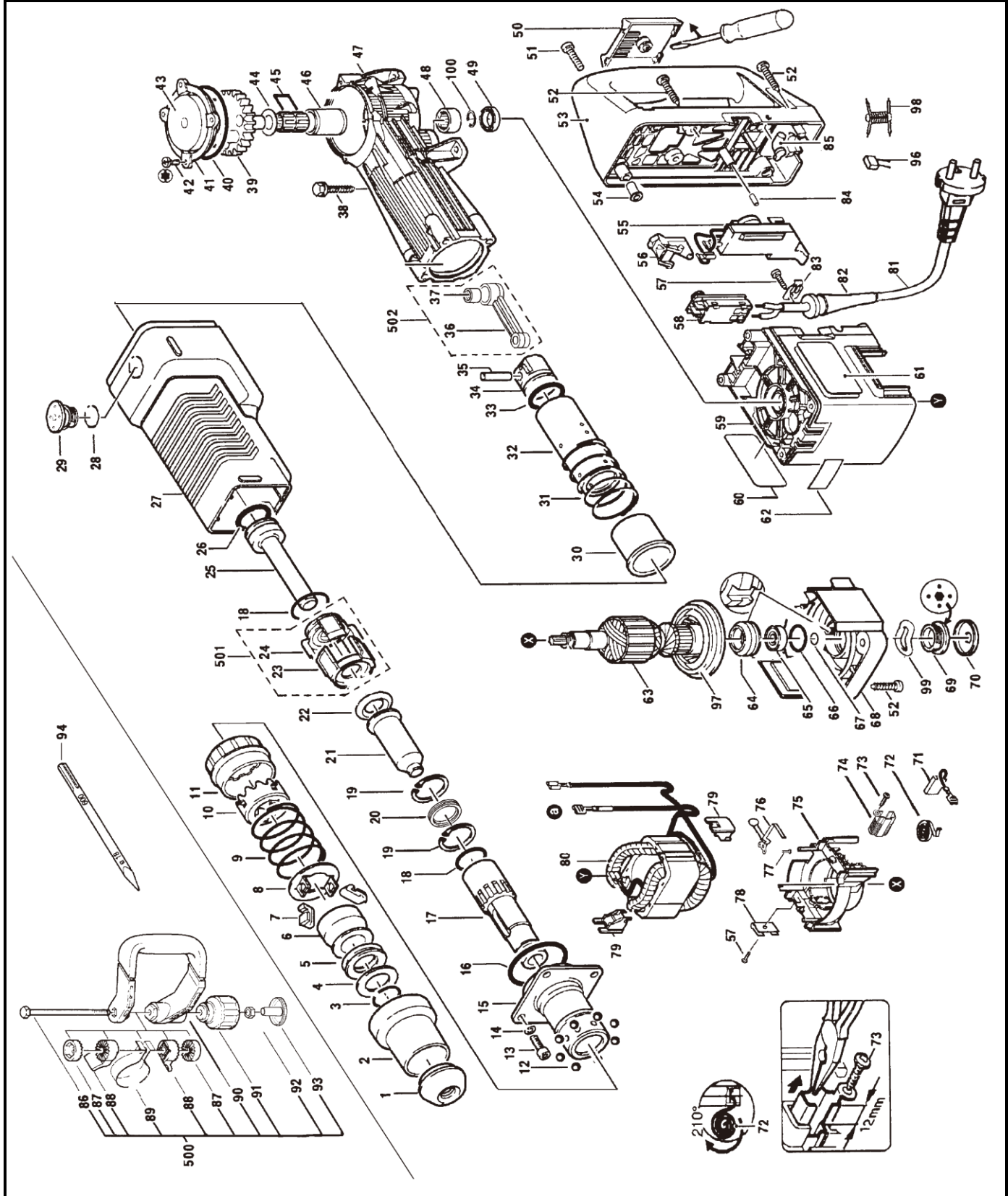

























FICHA TECNICA HERRAMIENTAS ELECTRICAS











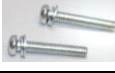









EQUIPO	CODIGO	DESCRIPCION	MODELO
	381749	CORTADORA DE MARMOL 110mm	TKDH-30-A
	ESPECIFICACIONES TECNICAS		
	POTENCIA:	1500W	VELOCIDAD:
VOLTAJE:	110V/60Hz	PESO:	10.7Kg.













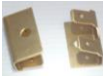

DESPIECE



N°	IMAGEN	CÓDIGO DE ESK	DESCRIPCIÓN	DATOS TECNICOS	COMPATIBILIDAD
1			ESCUDO CONTRA POLVO		
2			MANGUITO		
3			RETEN	31mm	
4			ARANDELA PLANA	43mm	
5			ESTOPERA		
6			MANGUITO DE TOPE		
7			CUNA DE BLOQUEO		
8			TRINQUETE DE BLOQUEO		
9			RESORTE		
10			ANILLO DE TRIQUETE		
11			MANGUITO DE TRIQUETE		
12			BOLA DE ACERO		
13			Tornillo de cabeza hexagonal exterior		
14			ARANDELA DE PRESION		
15			BASE		
16			JUNTA TORICA		
17			RETEN		
18			JUNTA TORICA		
19			RETEN		
20			JUNTA TORICA		
21			PERNO DE IMPACTO		
22			JUNTA TORICA		
23			DISCO DE CONTROL		
24			DISCO DE CONTROL		
25			EJE DE IMPACTO		

26			JUNTA TORICA		
27			CARCAZA PRINCIPAL		
28			JUNTA TORICA		
29			TAPA DE ACEITE		
30			TUBO GUIA		
31			RESORTE		
32			TUBO GUIA		
33		473348	PISTON		
34			JUNTA TORICA		
35			PASADOR DEL PISTON	9x37mm	
36			BIELA		
37			RODAMIENTO DE AGUJAS		
38			TORNILLO DE CABEZA HUECA HEXAGONAL		
39			ENGRANAJE EXCENTRICO		
40			JUNTA TORICA		
41			TAPA DE CAJA DE ENGRANAJES		
42			TORNILLO DE CABEZA HUECA HEXAGONAL		
43			SELLO DE FIELTRO		
44			ANILLO DE EMPUJE PLANO	29mm	
45			RODAMIENTO DE AGUJAS		
46			BUJE DE ACEITE		
47			CAJA DE ENGRANAJES		
48			RODAMIENTOS DE AGUJAS		
49			SELLO DE ACEITE		

50			INTERRUPTOR DE ENCENDIDO	PLASTICO	
51			TORNILLO DE CABEZA PLANA		
52			TORNILLO AUTORROSCANTE		
53			MANGO DE AGARRE		
54			MANGUITO		
55		485318	CONTROL DE VELOCIDAD		
56			ACCIONADOR DEL SWITCH	PLASTICO	
57			TORNILLO AUTORROSCANTE		
58		389247	SWITCH	1 617 200 048 1267.7101	
59			CARCAZA DEL MOTOR	NYLON	
60			ETIQUETA DE ESPECIFICACIONES		
61			ETIQUETA DE MARCA Y MODELO		
62			ETIQUETA DE SEGURIDAD		
63			INDUCIDO	53x38x205mm	
64			CASQUILLO AUTORROSCANTE		
65			RODAMIENTO	6200VV	
66			JUNTA TORICA		
67			RETEN	11mm	
68			TAPA DE LA CAJA DEL MOTOR	NYLON	
69			ANILLO ROSCADO	ACERO	
70			TAPA DEL ANILLO	PLASTICO	
71			Escobilla de carbón	LARGO: 25mm 15mm ALTO: ANCHO: 5mm	
72			RESORTE DEL PORTA CARBON		

73			TORNILLO		
74			PORTA CARBON	COBRE	
75			BASE DE LOS PORTA CARBONES	PLASTICO	
76			VINCULADOR DE CONTROL DE VELOCIDAD	COBRE	
77			TORNILLO		
78			VINCULADOR DEL CARBON	COBRE	
79			BLOQUE ESPACIADOR DEL CAMPO	PLASTICO	
80			CAMPO	70x91x80mm	
81			CABLE DE ALIMENTACION		
82			PROTECTOR DEL CABLE		
83			PROTECTOR DEL CABLE		
84			PASADOR DE GOMA		
85			CONDUCTOR DE LUZ		
86			TORNILLO DE CABEZA HEXAGONAL		
87			ENGRANE		
88			SOPORTE DE SUJECCION		
89			HOOP		
90			ASA LATERAL		
91			PERILLA		
92			TUERCA		
93			TAPA DE LA PERILLA		
94			SINCEL		
95			CAPACITOR	0.22UF	
97			VENTILADOR DE PLASTICO		
99				ARANDELA ONDULADA	38mm
100			RETEN		