

SOLDADOR INVERTER 160AMPS 110/220V 60%

Parte: SOLDADOR INVERTER

Código 508580

Modelo TKWI-160-B

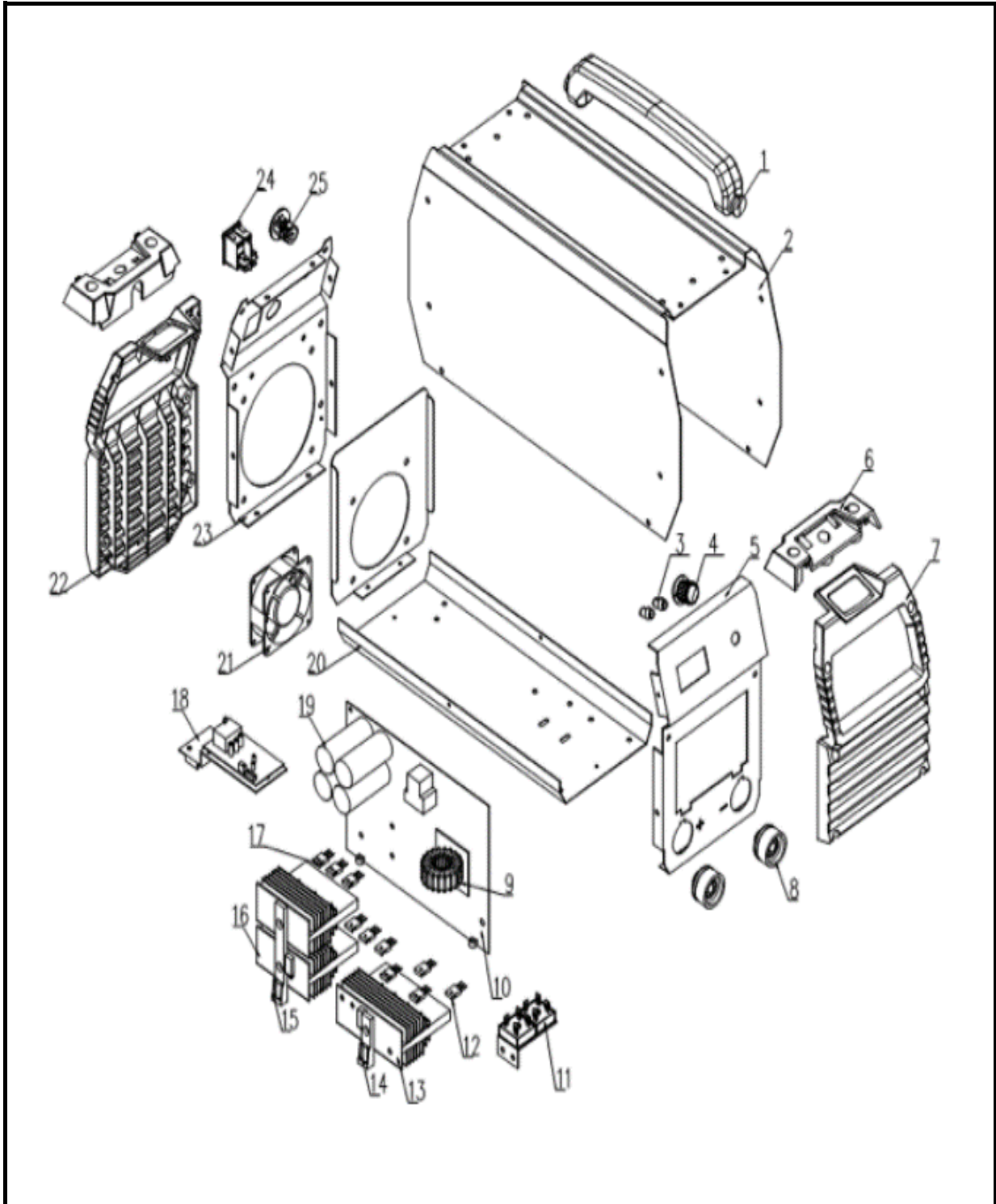

SOLDADOR INVERTER 160AMPS 110/220V 60%

 Parte: SOLDADOR INVERTER

 Código 508580

 Modelo TKWI-160-B

N°	Cód. Savake	Descripción Español	Descripción Ingles	Cant.	Observaciones
1			Handle	1	
2			Machine cover	1	
3			Indicator	2	
4			Knob	1	
5			Front panel	1	
6			Plastic protector	2	
7			Front panel	1	
8			Quick connector	2	
9			Main transformer	1	
10			Control board	1	
11			Bridge rectifier	2	
12			Fast recovery diode	4	
13			Radiator 1	1	
14			Plastic column 1	1	
15			Plastic column 2	1	
16			Radiator 2	2	
17			IGBT	6	
18			PCB board	1	
19			Electrolytic capacitor	4	
20			Bottom panel	1	
21			Fan	1	
22			Plastic back panel	1	
23			Rear panel	1	
24			Ignition switch	1	
25			Clip for power cord	1	