

FUMIGADORA LANZA 26 CC

Parte: MOTOR

Código 489575

Modelo TF900-A

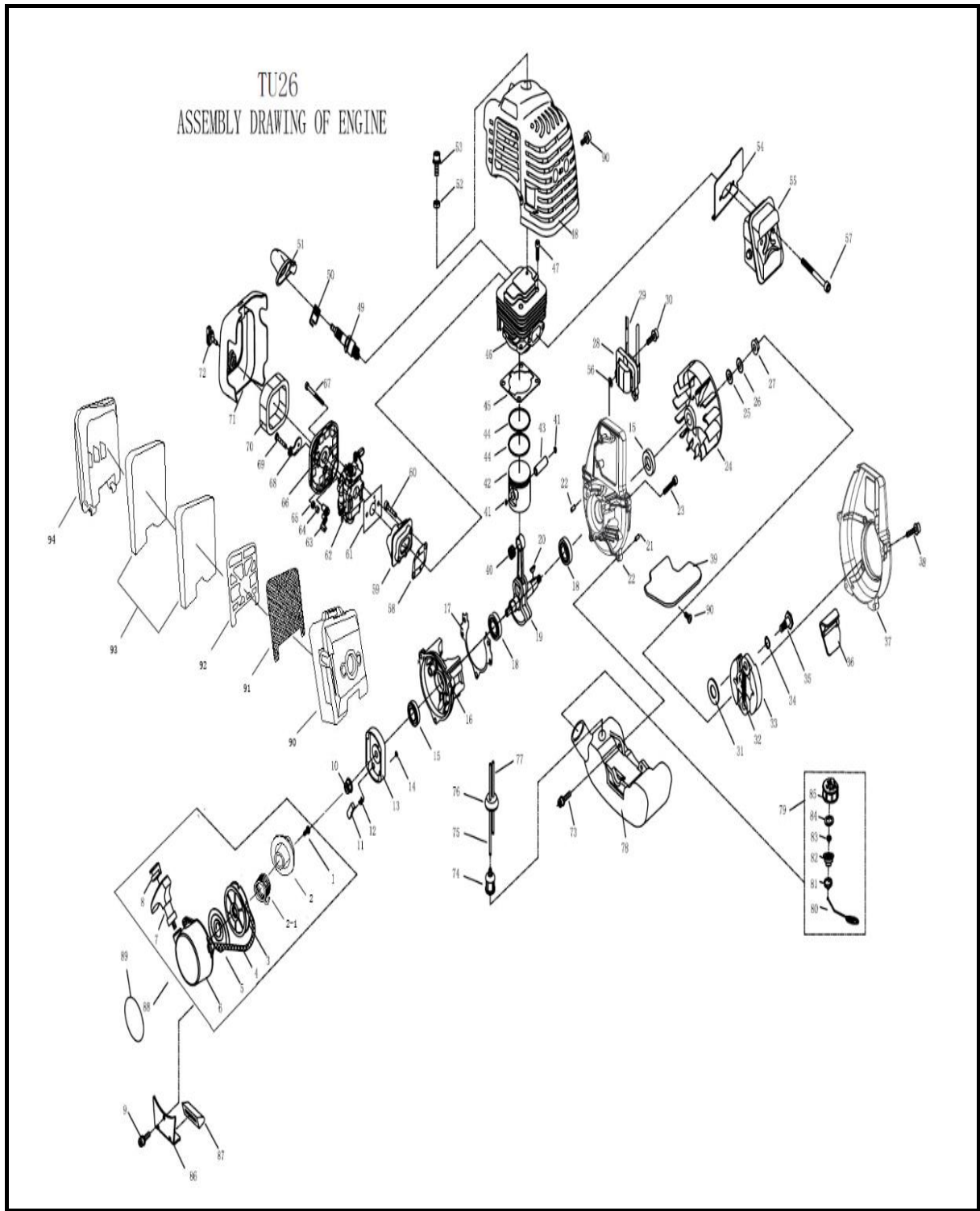

FUMIGADORA LANZA 26 CC

Parte: MOTOR

Código 489575

Modelo TF900-A

N°	Cód. Savake	Descripción Español	Descripción Ingles	Cant.	Observaciones
1	480186	TORNILLO CENTRAL P/TF900-A/XKS25L/ZKS25L/XS600/XS600	Screw m5x12		
2	492215	POLEA INTERIOR DE ARRANQUE P/TF900-A/XKS25L/ZKS25L/XS600	Wheel claw		
2-1			Spring		
3	492207	POLEA DE ARRANQUE P/TF900-A/XKS25L/ZKS25L/XS600	Starter whell		
4			Roper		
5	492199	RESORTE DE ARRANQUE P/TF900-A/XKS25L/ZKS25L/XS600	Recoil spring		
6	473884	CARCAZA DE ARRANQUE P/TF900-A/XKS25L/ZKS25L/XS600	Starter cover ass'y		
7	474213	MANIJA ARRANQUE P/TF900-A/XKS25L/ZKS25L/XS600	Starter handle		
8			No need		
9			No need		
10			No need		
11	492074	UÑA P/TF900-A/XKS25L/ZKS25L/XS600	Start claw		
12	492082	RESORTE DE TRINQUETE P/TF900-A/XKS25L/ZKS25L/XS600	Start spring		
11+12+13+14	492090	TRINQUETE COMPLETO P/TF900-A/XKS25L/ZKS25L/XS600	Start reel		
14			Stop ring 4		
15	492058	SELLO ACEITE CIGÜEÑAL P/TF900-A/XKS25L/ZKS25L/XS600	Oil - seal		
16			Crankcase back		
17	473967	EMPAQUE DEL CARTER P/TF900-A/XKS25L/ZKS25L/XS600	Gasket of crankcase		
18			Bearing 6001/p5		

FUMIGADORA LANZA 26 CC

Parte: MOTOR

Código 489575

Modelo TF900-A

N°	Cód. Savake	Descripción Español	Descripción Ingles	Cant.	Observaciones
19	491621	CIGÜEÑAL P/TF900-A/XKS25L/ZKS25L/XS600	Crankshaft		
20	465997	LLAVE DEL CIGUENAL P/TF900-A/XKS25L/ZKS25L/XS600	Key 3x5x12		
21			Pin b4 x 10		
22	450205	CARTER P/TF900-A/XKS25L/ZKS25L/XS600	Crankcase front		
37			Fan cover		
23			Screw m5 x 25		
24	472118	VOLANTE MANEGTO P/TF900-A/XKS25L/ZKS25L/XS600	Magneto rotor comp		
25			No need		
26			No need		
27			Nut m8		
28	492033	BOBINA ENCENDIDO P/TF900-A/XKS25L/ZKS25L/XS600	Ignition coil comp.		
29			No need		
30			Screw m5x20		
31	404491	ARANDELA EMBRAGUE P/TF900-A/XKS25L/ZKS25L/XS600	Washer		
32	474320	RESORTE EMBRAGUE P/TF900-A/XKS25L/ZKS25L/XS600	Expander spring		
32	492124	EMBRAGUE COMPLETO P/TF900-A/XKS25L/ZKS25L/XS600	Expander spring		
33			Expander complete		
34			Washer		
35			Screw pin		
34	474908	ARANDELA DE EMBRAGUE P/TF900-A/XKS25L/ZKS25L/XS600	Washer		
35			Screw pin		
36			Plate		
37			Fan cover		
38			Bolt m5 x 20		
39			Plate		

FUMIGADORA LANZA 26 CC

Parte: MOTOR

Código 489575

Modelo TF900-A

N°	Cód. Savake	Descripción Español	Descripción Ingles	Cant.	Observaciones
40	404111	PISTON COMPLETO MOTOR P/TF900-A/XKS25L/ZKS25L/XS600	Bearing		
42			Piston		
43			Piston pin		
44			Piston ring	2	
40	473850	RODAMIENTO AGUJAS P/TF900-A/XKS25L/ZKS25L/XS600	Bearing		
41	491605	CLIP P/TF900-A/XKS25L/ZKS25L/XS600	Ring		
42	491589	PISTON P/TF900-A/XKS25L/ZKS25L/XS600	Piston		
43	491597	PASADOR DEL PISTON P/TF900-A/XKS25L/ZKS25L/XS600	Piston pin		
44	491571	ANILLOS DE PISTON P/TF900-A/XKS25L/ZKS25L/XS600	Piston ring	2	
45	491563	EMPAQUE DEL CILINDRO P/TF900-A/XKS25L/ZKS25L/XS600	Gasket of cylinder		
46	491548	CILINDRO P/TF900-A/XKS25L/ZKS25L/XS600	Cylinder		
47			Screw for cylinder		
48	474437	TAPA PROTECTORA MOTOR P/TF900-A/XKS25L/ZKS25L/XS600	Guide cover assy		
49			Spark plug		
50			Spring		
51	473868	CAPUCHON BUJIA P/TF900-A/XKS25L/ZKS25L/XS600	Cover of spark plug		
52+53			Screw m5x16		
54	474015	EMPAQUE SILENCIADOR P/TF900-A/XKS25L/ZKS25L/XS600	Gasket		
55	474064	SILENCIADOR P/TF900-A/XKS25L/ZKS25L/XS600	Muffler		
56			No need		
57			Bolt M5X45		

FUMIGADORA LANZA 26 CC

Parte: MOTOR

Código 489575

Modelo TF900-A

N°	Cód. Savake	Descripción Español	Descripción Ingles	Cant.	Observaciones
58	474833	EMPAQUE DEL INSULADOR P/TF900-A/XKS25L/ZKS25L/XS600	Gasket of admitting pipe		
59	474163	INSULADOR P/TF900-A/XKS25L/ZKS25L/XS600	Admitting pipe		
60	404475	TORNILLO SUJETADOR DE CARBURADOR P/TF900-A/XKS25L/ZKS25L/XS600	Screw m5x25		
61	480178	EMPAQUE DEL CARBURADOR P/TF900-A/XKS25L/ZKS25L/XS600	Gasket of carburetor		
62	492157	CARBURADOR P/TF900-A/XKS25L/ZKS25L/XS600	Carburetor(ruixin h119-00-135)		
63-66+68+69			Inside cover of air cleaning		
66	473900	CARCAZA FILTRO AIRE P/TF900-A/XKS25L/ZKS25L/XS600	Inside cover of air cleaning		
67			Screw m5x60		
68	474262	PALANCA CHOKE P/TF900-A/XKS25L/ZKS25L/XS600			
70			Fan		
71	474429	TAPA FILTRO DE AIRE P/TF900-A/XKS25L/ZKS25L/XS600	Outside cover of air cleaning		
72	474478	TORNILLO TAPA FILTRO DE AIRE P/TF900-A/XKS25L/ZKS25L/XS600	Screw for air cleaning		
73	474460	TORNILLO AJUSTE BASE TANQ COMB P/TF900-A/XKS25L/ZKS25L/XS600	Screw for fuel tank		
74	474080	FILTRO DE COMBUSTIBLE P/TF900-A/XKS25L/ZKS25L/XS600	Fuel pipe filter		
75	482000	MANGUERA DE SUCCION COMBUSTIBLE P/TF900-A/XKS25L/ZKS25L/XS600	Fuel pipe(suction)		
76	473991	EMPAQUE MANGUERA COMBUSTIBLE P/TF900-A/XKS25L/ZKS25L/XS600/XS600	Fuel plug		

FUMIGADORA LANZA 26 CC

Parte: MOTOR

Código 489575

Modelo TF900-A

N°	Cód. Savake	Descripción Español	Descripción Ingles	Cant.	Observaciones
77	474189	MANGUERA DE RETORNO COMBUSTIBLE P/TF900-A/XKS25L/ZKS25L/XS600	Fuel pipe(overflow)		
78	474403	TANQUE DE COMBUSTIBLE P/TF900-A/XKS25L/ZKS25L/XS600	Fuel tank		
78	492116	TANQUE DE COMBUSTIBLE CON ACC P/TF900-A/XKS25L/ZKS25L/XS600	Fuel tank		
79			Fuel tank cover		
81	474031	EMPAQUE TAPA COMBUSTIBLE P/TF900-A/XKS25L/ZKS25L/XS600	FUEL CAP GASKET		
86			NO HAVE		
87			NO HAVE		
88	492108	ARRANQUE COMPLETO P/TF900-A/XKS25L/ZKS25L/XS600	STARTER COMPLETE		
89			STARTER LABEL		
90-94			AIR CLEANER ANOTHER TYPE, YOUR TYPE N		
58-72			AIR CLEANER NORMAL TYPE , your type is t		
91	492165	ELEMENTO FILTRO DE AIRE P/TF900-A/XKS25L/ZKS25L/XS600			
58-72	491555	FILTRO DE AIRE P/TF900-A/XKS25L/ZKS25L/XS600	AIR CLEANER NORMAL TYPE , your type is t		

FUMIGADORA LANZA 26 CC

Parte: BOMBA

Código 489575

Modelo TF900-A

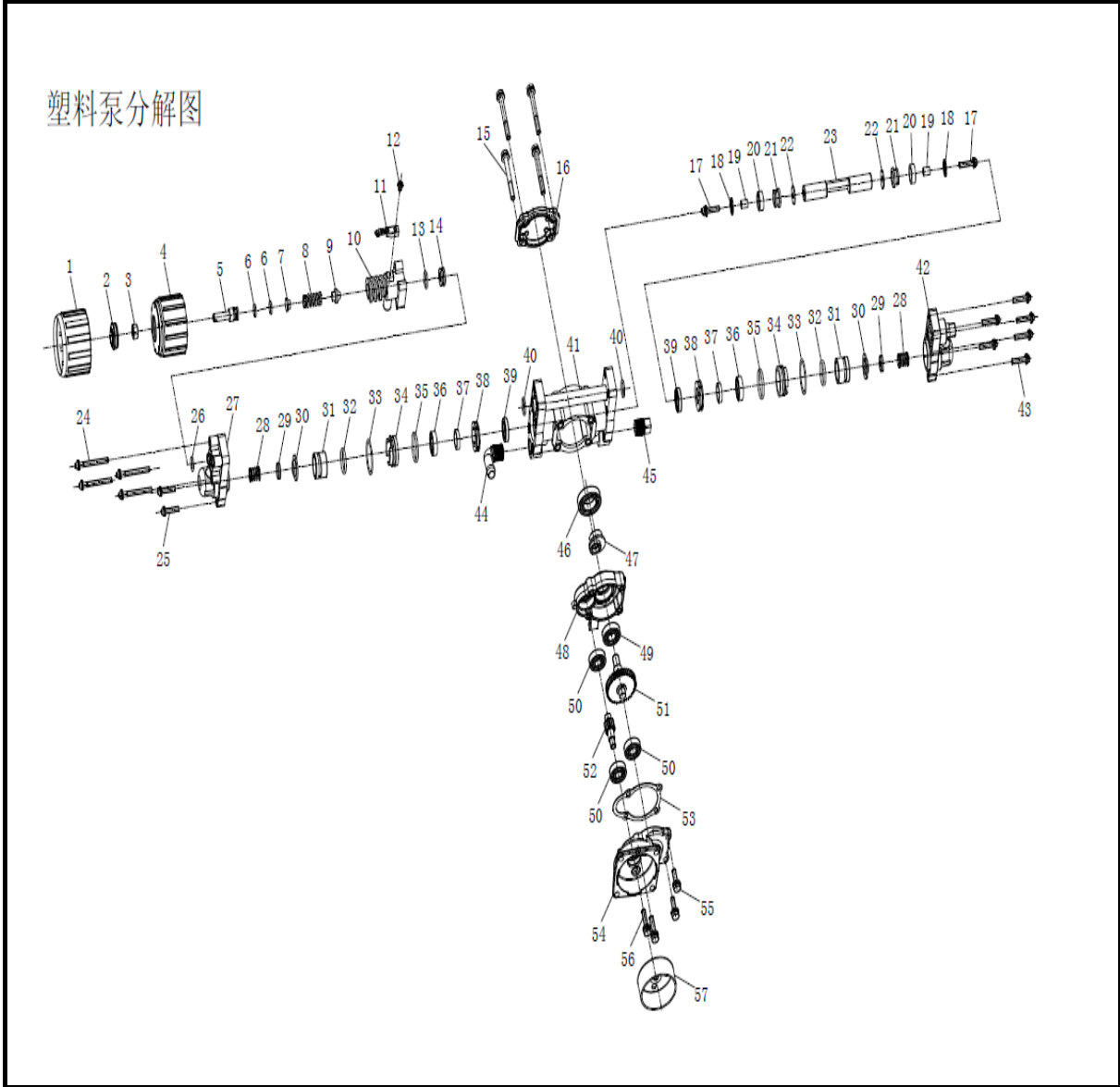





FUMIGADORA LANZA 26 CC

Parte: BOMBA

Código 489575

Modelo TF900-A

N°	Cód. Savake	Descripción Español	Descripción Ingles	Cant.	Observaciones
1...57	509497	BOMBA NYLON P/TF900-A	NYLON PUMP SPRAYER FOR TF900-A		
1			rubber cap		
2			wheel		
3			nut M8		
4	473959	PERILLA VALVULA P/TF900-A	adjusting wheel		
5	471946	PIN DEL RESORTE TF900	adjusting pressure rod		
6			O ring 13X1.8		
7	474890	ASIEN TO RESORTE VALVULA P/TF900-A	spring seat		
8	474353	RESORTE BOMBA P/T900-A	spring		
9			cone		
10			adjusting pressure body		
11			plate		
12			screw ST4.2X9		
13	474247	O-RING P/TF900-A	O ring 18X2.3		
14	404665	ASIEN TO VALVULA P/TF900-A	adjusting pressure seat		
15			screw complete M6X55		
16			crankcase cover		
17			screw complete M5x25		
18			discharge ring		
19			tube		
20	550756	EMPAQUE DE PRESION P/TF900-A	piston		
21	550780	BASE DEL EMPAQUE DE PRESION P/TF900-A	valve rubber		
22			suction ring		
23	519595	EMBOLO BOMBA P/TF900-A	plunger		
24			screw complete M5X50		
25			screw complete M5X25		
26	474221	O-RING P/TF900-A	O ring 14X2.2		

FUMIGADORA LANZA 26 CC

Parte: BOMBA

Código 489575

Modelo TF900-A

N°	Cód. Savake	Descripción Español	Descripción Ingles	Cant.	Observaciones
27	404640	SOPORTE VÁLVULA LADO REGULADOR	overflow metal		
28	480111	RESORTE VALVULA BOMBA P/TF900-A	spring		
29	473694	ANILLO BASE CILINDRO P/TF900-A	back valve		
30	474528	VALVULA MONEDA VRP P/TF900	valve disk		
31	404590	CILINDRO DE BOMBA P/TF900-A	cylinder bushing		
32	473660	ANILLO BOMBA P/TF900-A	O ring 20X2.65		
33	474874	ANILLO BOMBA P/TF900-A	O ring 35X1.9		
34	473736	ASIENTO SELLO AGUA P/TF900-A	oil seal seat		
35			O ring 31X2.3		
36	474387	SELLO DE AGUA BOMBA P/TF900-A	oil seal 16X24X6		
37	473702	ARANDELA JUEGO BLOCK P/TF900-A	felt ring		
38	473710	ARANDELA JUEGO DE BLOCK P/TF900-A	felt seat		
39	473744	ASIENTO VALVULA P/TF900-A	oil seal 16X24X5		
40	473694	ANILLO BASE CILINDRO P/TF900-A	O ring 18X2.65		
41	450171	CILINDRO BOMBA P/TF900-A	cylinder		
41	480103	CUERPO DE LA BOMBA P/TF900-A	PUMP BODY		
42	471938	SOPORTE VÁLVULA LADO ACELERADOR	discharge metal		
43			screw completeM5X25		
44	471995	CODO SUCCION MANGUERA P/TF900-A	suction connector		
45	450189	TAPON BOMBA P/TF900-A	plug		

FUMIGADORA LANZA 26 CC

Parte: BOMBA

Código 489575

Modelo TF900-A

N°	Cód. Savake	Descripción Español	Descripción Ingles	Cant.	Observaciones
46	450809	RODAMIENTO 6004 BOMBA P/TF900-A	bearing 61904		
47	471888	TUERCA EXCENTRICA P/TF900-A	wheel		
48	482141	TAPA CAJA CAMPANA LADO B P/TF900-A	crankcase		
49	471862	ROLINERA 6001 BOMBA P/TF900-A	bearing		
50	480095	ROLINERA 6000 BOMBA P/TF900-A	bearing		
51	450593	PINON CENTRAL P/TF900-A	gear		
52	474288	PIÑON GUIA P/TF900-A	gear shaft		
53			gasket		
54	482133	TAPA CAJA CAMPANA LADO A P/TF900-A	drum case		
55			screw complete M6X20		
56			screw complete M6X25		
57	473843	CAMPANA DEL EMBRAGUE P/TF900-A	drum clutch		
48...57	482091	CAJA COMPLETA REDUCTORA P/TF900-A			

FUMIGADORA LANZA 26 CC

Parte: FUMIGADORA

Código 489575

Modelo TF900-A

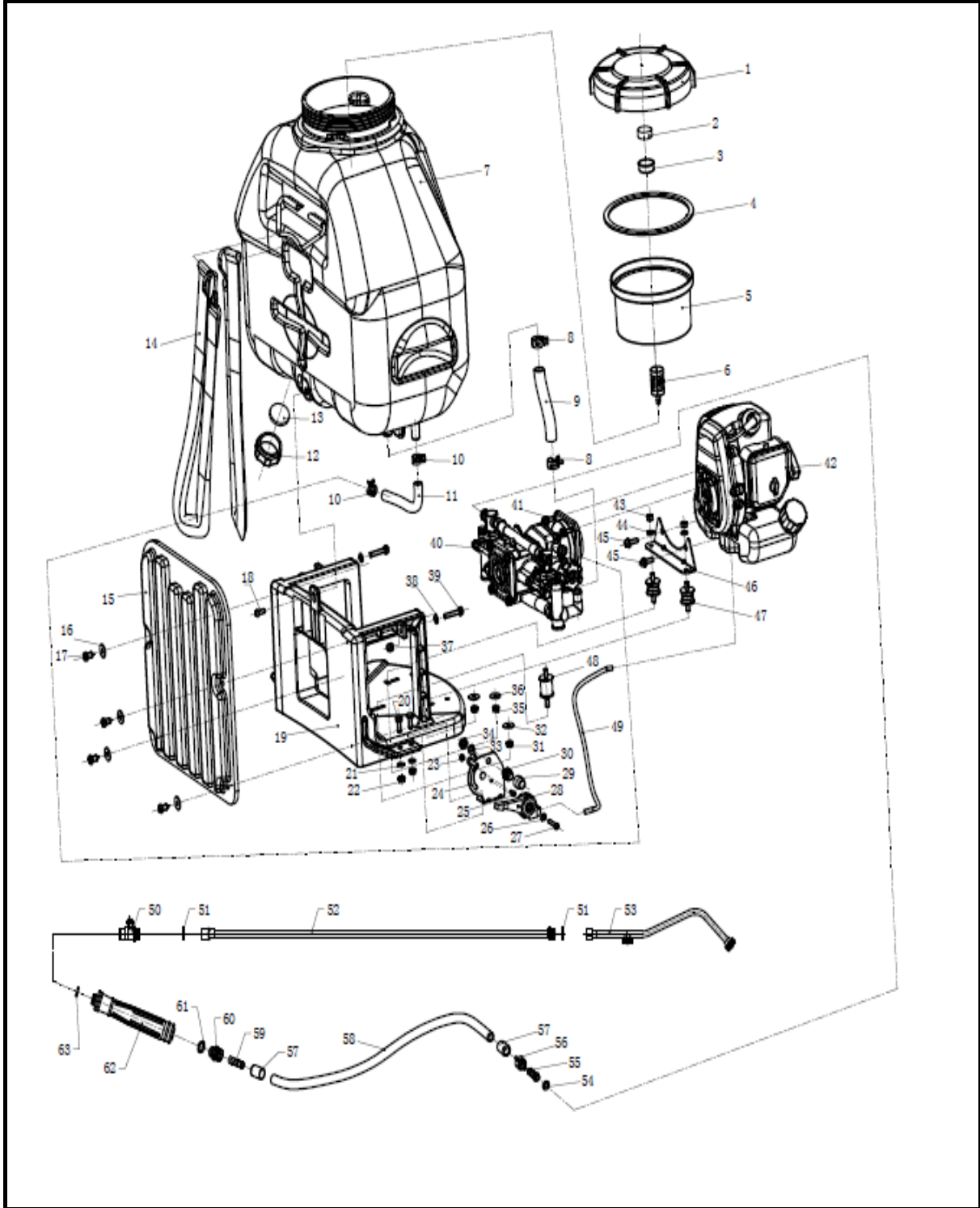

FUMIGADORA LANZA 26 CC

Parte: FUMIGADORA

Código 489575

Modelo TF900-A

N°	Cód. Savake	Descripción Español	Descripción Ingles	Cant.	Observaciones
1+2+3	509117	TAPA TANQUE QUIM P/TF900-A/XKS25L/ZKS25L	Container cover		
4	404467	EMPAQUE TAPA TANQUE QUIMICO P/TF900-A/XKS25L/ZKS25L	Gasket		
5	511360	FILTRO QUIMICO P/TF900-A/XKS25L/ZKS25L	Filter		
6			small filter in the tank		
7	501627	TANQUE QUIMICO P/TF900-A/XKS25L/ZKS25L	Chemical container with Chain holder 900		
8			Clip-L(suction hose)		
9	471979	MANGUERA DE SUCCION P/TF900-A/XKS25L/ZKS25L	suction hose		
10			Clip-S(overflow hose)		
11	471961	MANGUERA DE RETORNO P/TF900-A/XKS25L/ZKS25L	overflow hose with spring		
12	511345	TAPA DEL DRENAJE P/TF-900-A/XKS25L/ZKS25L	Drain cup		
13	474049	EMPAQUE DEL DRENAJE P/XKS25L-ZKS25L-TF900-A	gasket for drain cup		
14	511329	CORREAS JUEGO P/TF900-A/XKS25L/ZKS25L	Strap (one set = 2pcs)		
15	511352	ESPALDAR PARA P/TF900-A/XKS25L/ZKS25L	Pad for 900		
16			NO NEED		
17			screw M6X16 for stand pad		
18			screw M6X12 for tank		
19	511295	BASE DEL TANQUE P/TF900-A/XKS25L/ZKS25L	frame complete		
20+21+22			screw M6X16, 06 gasket and nut M6 for fix		
23+24+25+26 +27+28+29+3 0+31+32+33+ 34			plate complete		

FUMIGADORA LANZA 26 CC

Parte: FUMIGADORA

Código 489575

Modelo TF900-A





N°	Cód. Savake	Descripción Español	Descripción Ingles	Cant.	Observaciones
24	480087	PLATINA P/TF900-A/XKS25L/ZKS25L	plate		
28	474148	GATILLO ACELERACION P/TF900-A/XKS25L/ZKS25L	Flex accelerator		
30	404442	BOTON DE APAGADO P/TF900-A/XKS25L/ZKS25L	Cord comp		
35			nut		
36			gasket		
37			nut		
38			NO NEED		
39			screw M6X16 for stand		
40	509497	BOMBA NYLON P/TF900-A	brass pump for 2 stroke		
41			screw M5X14 of engine		
42	482158	MOTOR GASOLINA P/TF900-A/XKS25L/ZKS25L	FST TU26 engine		
43			nut		
44			gasket		
45	450791	TUERCA DE BASE P/TF900-A/XKS25L/ZKS25L	screw M6X16 for stand		
46			engine stand		
47	450775	AMORTIGUADOR SOPORTE MOTOR P/TF900-A/XKS25L/ZKS25L/XS600	joint-S		
48	512772	AMORTIGUADOR SOPORTE BOMBA P/TF900-A/XKS25L/ZKS25L/XS600	Joint-L		
49	474155	GUAYA DE ACELERACION P/TF900-A/XKS25L/ZKS25L	Cable comp		
50	404624	LLAVE DE PASO MACHO-HEMBRA P/TF900-A/XKS25L/ZKS25L	outlet cock		
51	454199	EMPAQUE DE VALVULA DE SALIDA P/TF900-A/XKS25L/ZKS25L	gasket for outlet cock		

FUMIGADORA LANZA 26 CC

Parte: FUMIGADORA

Código 489575

Modelo TF900-A

N°	Cód. Savake	Descripción Español	Descripción Ingles	Cant.	Observaciones
52	474486	TUBO DESCARGUE P/TF900-A/XKS25L/ZKS25L	sprayer rod		
53	511386	BOQUILLA METALICA P/TF900A/XKS25L/ZKS25L	2 nozzle gun		
54+55+56			female hose connector		
57			hose pipe		
58	511378	MANGUERA DESCARGA P/TF900-A/XKS25L/ZKS25L	1.5m hose		
59+60+61			male hose connector		
54+55+56	474205	MANGUERA COMPLETA P/TF900-A	female hose connector		
57			hose pipe		
58			1.5m hose		
59+60+61			male hose connector		
62	472035	MANGO DE LANZA P/TF900-A/XKS25L/ZKS25L	handle		
63			gasket for handle		