

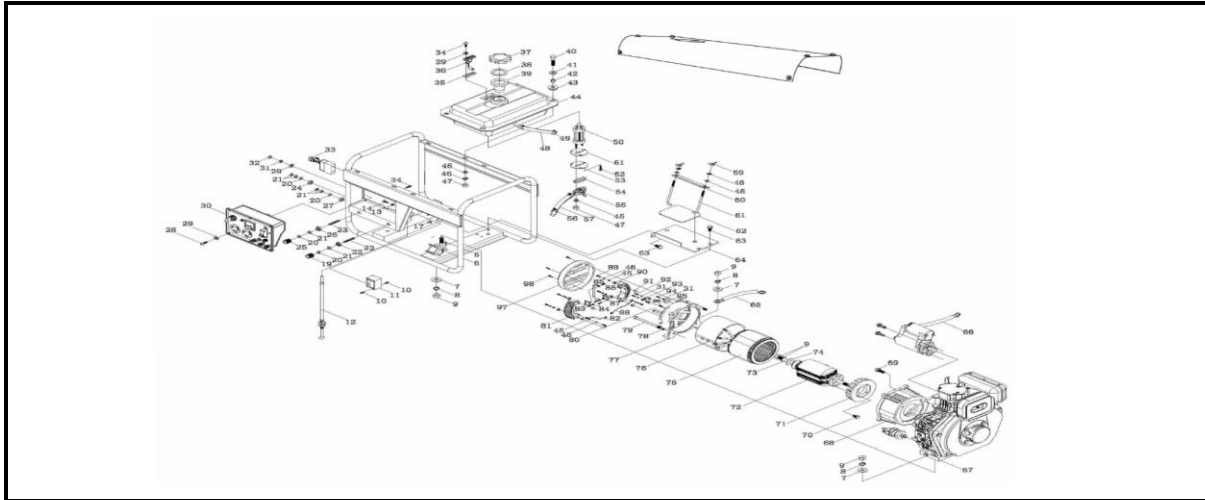

MOTORSOLDADOR DIESEL 12HP
MÁQUINA

Parte: _____

Código 474783 _____

Modelo XDW200E _____



N°	Cód. Savake	Descripción Español	Descripción Ingles	Cant.	Observaciones
1			Housing Weldment Assembly	1	
2			Wheel spacer	8	
3			wheel	4	
4			Cotter Pin	4	
5			Bolt M10 x 45	4	
6	527770	AMORTIGUADOR TANQUE COMBUSTIBLE P/XDW200E	Damping block	4	
7			Washerφ10	8	
8			Washerφ10	8	
9			Nut M10	10	
10			Screw M4 x 8	2	
11			electromagnet	1	
12			cabale accelerator	1	
13			gasket	4	
14			Screw M3 x 8	4	
15			Bolt M8 x 35	2	
16			dead plate (right)	1	
17			Nut M8	2	
18			dead plate (left)	1	
19	506766	TORNILLO POSITIVO-NEGATIVO P/XDW200E	Conection Pole Unit Cap (red)	1	
25			Conection Pole Unit Cap (black)	1	
20			Washerφ8	4	
21			Nut M8 (thin)	6	
22			Conection Pole Unit Fastening bracket 1 (red)	1	
23			Conection Pole Unit	2	
24			Conection Pole Unit Fastening bracket 2 (red)	1	
26			Conection Pole Unit Fastening bracket 1 (black)	1	
27			Conection Pole Unit Fastening bracket 2 (black)	1	
28			Screw M5 x 16	4	
29			Washerφ5	10	
30			control pannel	1	
31			Washerφ5	7	
32			Nut M5	12	

MOTORSOLDADOR DIESEL 12HP
MÁQUINA

Parte: _____

Código 474783

Modelo XDW200E

N°	Cód. Savake	Descripción Español	Descripción Ingles	Cant.	Observaciones
33	498436	AVR 200AMPS P/XDW200E	AVR	1	
	507731	AVR 200AMPS DE 3 PUNTAS P/XDW200E		1	
34			Screw M5 x 8	4	
35			Fuel Lever Mark washer	1	
36			Fuel Lever Mark	1	
37			Fuel Tank Cap	1	
38			Fuel Tank Seal	1	
39			Fuel Oil Filter	1	
40			Bolt M6 x 22	8	
41			Washerφ6	8	
42			Collar	8	
43			Shock Absorber	8	
44	503235	TANQUE DE COMBUSTIBLE 12L P/XDW200E	Fuel Tank Assembly	1	
45			Washerφ6	18	
46			Washerφ6	16	
47			Nut M6	10	
48			Fuel Return Pipe	1	
49			Fuel Return Pipe Clip	2	
50			Fuel Filter Assembly	1	
51			Diesel filter gasket	1	
52			Diesel oil filter press plate	1	
53			Screw M5 x 10	3	
54			Oil switch gasket	1	
55			Fuel Tank Switch Assembly	1	
56			Fuel Filter Pipe Clip	2	
57			Fuel Filter Pipe	1	
55			Fuel Tank Switch Assembly	1	
56			Fuel Filter Pipe Clip	2	
57			Fuel Filter Pipe	1	
58			Big plate (with logo)	1	
59			Nut M6	2	
60			The battery layering	1	
61			Battery hook	2	
62			Battery gasket	1	
63			BoltM6*12	4	
64			battery plate	1	
65			battery cable (black)	1	
66			battery cable (red)	1	
67			192FA engine	1	
68			alternator front cover	1	
69			BoltM8*28	4	
70			BoltM5*18	4	
71			fan blade	1	
72	511675	INDUCIDO P/XDW200E	rotor assembly	1	
73			Center for stud M10x276	1	
74			Washerφ10	1	
75	511659	CAMPO P/XDW200E	stator	1	
76			stator shield	1	
77			alternator back cover	1	
78			Washer φ8	4	
79			Bolt M8 x 156	4	
80			Bolt M6 x 14	2	
81	503243	DIODE P/XDW200E	Conection Pole Unit cooling fin	2	
82			Welding line (+)	1	
83			Anode Conection Pole Unit (green)	3	
84			Screw M4 x 10	24	
85			wire	3	

MOTORSOLDADOR DIESEL 12HP

Parte: MAQUINA

Código 474783

Modelo XDW200E

N°	Cód. Savake	Descripción Español	Descripción Ingles	Cant.	Observaciones
86			BoltM6*8	6	
87			Negative Conection Pole Unit (Black)	3	
88			Welding line (-)	1	
89			BoltM6*30	4	
90			Shock Absorber 1	4	
91			Shock Absorber 2	4	
92			Screw M5 x 15	2	
93	476481	CARBONERA P/XDW200E	brush	1	
94			Screw M5 x 18	1	
95			commutator bar	1	
96			Screw M5 x 12	1	
97			alternator rear end cover	1	
98			Bolt M6 x 16	3	

MOTORSOLDADOR DIESEL 12HP
MOTOR

Parte: _____

Código 474783 _____

Modelo XDW200E _____









MOTORSOLDADOR DIESEL 12HP
MOTOR 12HP

Parte: _____

Código 474783

Modelo XDW200E

N°	Cód. Savake	Descripción Español	Descripción Ingles	Cant.	Observaciones
56	476515	TAPA VALVULAS P/MOTOR 12HP (192FA) 499cc	Cylinder head cover gasket	1	
57			Cylinder head cover	1	
58			Aluminum block 8*8	1	
59			Pressure reducing spring	1	
60			O-ring f10*1.9	1	
61			Pressure reducing handle	1	
62			Pin 3*16	1	
63			Flange bolt M6*70	3	
64			Respirator	1	
65			O-ring f12*1.9	1	
66			External pressure reducing handle	1	
67			External decompression handle rubber sleeve	2	
68			Pull rod	1	
69			External decompression control handle	1	
70			External decompression handle handle	1	
71	Flange bolt M6*14	3			
72	Flange nut M6	1			
73	External decompression handle bushing	1			
74	476549	ANILLOS DEL PISTON P/MOTOR 12HP (192FA) 499cc	First oil ring	1	
75			Second oil ring	1	
76			Third gas ring	1	
77	527812	PISTON P/MOTOR 12HP (192FA) 499cc	piston	1	
78			Piston pin	1	
79			Hole retaining ring 23	2	
80	476531	BIELA P/MOTOR 12HP (192FA) 499cc	link	1	
81	476556	CONCHAS DE BIELA P/MOTOR 12HP (192FA) 499cc	Connecting rod	1	
82	476564	CONTRA PESO CIGÜEÑAL P/MOTOR 12HP (192FA) 499cc	Balance axis	1	
83			Flat key 5*7	2	
84			Balance shaft drive gear	1	
85			Flange bolt	1	
86			Flat pad	1	
87			Crankshaft timing gear	1	
88			Flat key 6*50	1	
89	476572	CIGÜEÑAL P/MOTOR 12HP (192FA) 499cc	Crankshaft	1	
90			Aluminum block 6x8	1	
91			Flat key 5*14	3	
92			Balance shaft gear	1	
93			Bearing 6308P5	1	
94			flywheel	1	
95			Flywheel nut washer	1	
96			Flywheel nut	1	
97			Starting claw	1	
98			Flange bolt M6*12	4	
99			Valve push rod	2	
100			Valve tappet	2	
101	476580	ARBOL DE LEVA P/MOTOR 12HP (192FA) 499cc	Camshaft	1	
102			Camshaft timing gear	1	

MOTORSOLDADOR DIESEL 12HP
MOTOR 12HP

Parte: _____

Código 474783

Modelo XDW200E



N°	Cód. Savake	Descripción Español	Descripción Ingles	Cant.	Observaciones
103			Intake pipe	1	
104			Stud	1	
105			Flange bolt M6*25	3	
106	476598	FILTRO AIRE COMPLETO P/XDE12TK /XDW200E	Air filter gasket	1	
107			Air filter bottom case	1	
108			Flange nut M6	3	
109			Anti-vibration seal II	1	
110			Air filter	1	
111			Shock absorbers	1	
112			Seal ring	1	
113			Anti-vibration seal I	1	
114			Air filter housing	1	
115			Shockproof seal assembly	1	
116			Butterfly nut M6	1	
111	527788	ELEMENTO FILTRO AIRE P/XDE12TK /XDW200E	Shock absorbers	1	
112			Seal ring	1	
	476697	FILTRO AIRE (BAÑADO EN ACEITE) P/XDE12TK /XDW200E	AIR FILTER (OIL BATH)	1	
117	476606	SILENCIADOR P/MOTOR 12HP (192FA) 499cc	Hex nut M8	2	
118			Spring pad 8	2	
119			Flat pad 8	2	
120			silencer	1	
121			Flange bolt M8*16	2	
122			Flange bolt M6*16	3	
123			Oil pump plate	1	
124			O-ring f34.5*1.8	1	
125	476614	BOMBA DE ACEITE P/MOTOR 12HP (192FA) 499cc	Oil pump	1	
126			Pin 3*16	1	
127			O-ring f19*2.65	1	
128	476622	FILTRO DE ACEITE P/MOTOR 12HP (192FA) 499cc	Oil filter	1	
129			Flange bolt M6*14	1	
130			Oil conduit	1	
131			Oil pump drive gear	1	
132			Push plate	1	
133			Hex nut M10*1.25	1	
134			Oil limiter	1	
135			handle	1	
136			Flange bolt M6*14	1	
137			Flange bolt M6*20	1	
138			Return spring II	1	
139			Return spring I	1	
140			Speed ??control spring	1	
141			Fork assembly	1	
142			Fuel tank cap	1	
143			Oil Cup	1	
144	527796	FILTRO DE COMBUSTIBLE P/XDE12TK /XDW200E	Diesel filter	1	
145			Diesel filter gasket	1	

MOTORSOLDADOR DIESEL 12HP
MOTOR 12HP

Parte: _____

Código 474783

Modelo XDW200E

N°	Cód. Savake	Descripción Español	Descripción Ingles	Cant.	Observaciones
146			Oil switch gasket	1	
147			Oil switch	1	
148	527804	LLAVE DE COMBUSTIBLE P/MOTOR 12HP (192FA) 499cc	High-pressure pipeline	1	
149			Oil pipeline	1	
150			Oil pipeline card	2	
151			Hex nut M6	2	
152			Flange bolt M6*14	2	
153			Fuel tank lower bracket	1	
154			Fuel tank rubber block	4	
155	503235	TANQUE DE COMBUSTIBLE 12L P/XDW200E	tank	1	
156			Oil return pipe	1	
157			Return pipe clamp	2	
158			Fuel tank upper bracket	1	
159			Flat pad 8	2	
156			Oil return pipe	1	
157			Return pipe clamp	2	
158			Fuel tank upper bracket	1	
159			Flat pad 8	2	
160			Shaped screw 1 bolt		
161			Flange bolt M8*45	1	
162			Fuel injection pump gasket	1	
163	527952	BOMBA DE INYECCION P/MOTOR 12HP (192FA) 499cc	Fuel injection pump	1	
164			Sealing plate gasket	1	
165			sealing board	1	
166			Flange nut M6	3	
167			Air hood seal	1	
168			Wind shield	1	
169			Air dam cushion	4	
170			Windshield cushion cover	4	
171			Flat pad 6	4	
172			Hex bolt M6*25	4	
173			Hand tray	1	
174			Flange bolt M6*8	4	
174*	476655	ARRANQUE COMPLETO P/MOTOR 12HP (192FA) 499cc	Recoil stater eassy	1	
175	476648	INYECTOR P/MOTOR 12HP (192FA) 499cc	Injector	1	
176			Flange bolt M10*20	2	
176-1			Flange bolt M10*30	2	
177			Spring pad 10	2	
178	394460	ARRANQUE ELECTRICO P/XDG5500E /XDG5500C /XDW200E	Starter 0.75KW	1	
178-1			Starter hole plug cover	1	
179			Flywheel generator rotor	1	
183	476663	BOBINA EXITADORA P/XDE12TK /XDW200E	Crimping board	1	
184			Flywheel generator stator	1	

MOTORSOLDADOR DIESEL 12HP

Parte: MOTOR

Código 474783

Modelo XDW200E

N°	Cód. Savake	Descripción Español	Descripción Ingles	Cant.	Observaciones
180			Cross countersunk head screw M6*14	3	
181			Flange bolt M6*20	3	
182			Flange bolt M6*12	1	
185			Cross round head screw M6*12	2	
186			Voltage regulator block	1	
187			Flange bolt M6*14	2	
188	476671	REGULADOR DE VOLTAJE P/MOTOR 12HP (192FA) 499cc	Voltage regulator bracket	1	
189			Flywheel ring gear	1	