

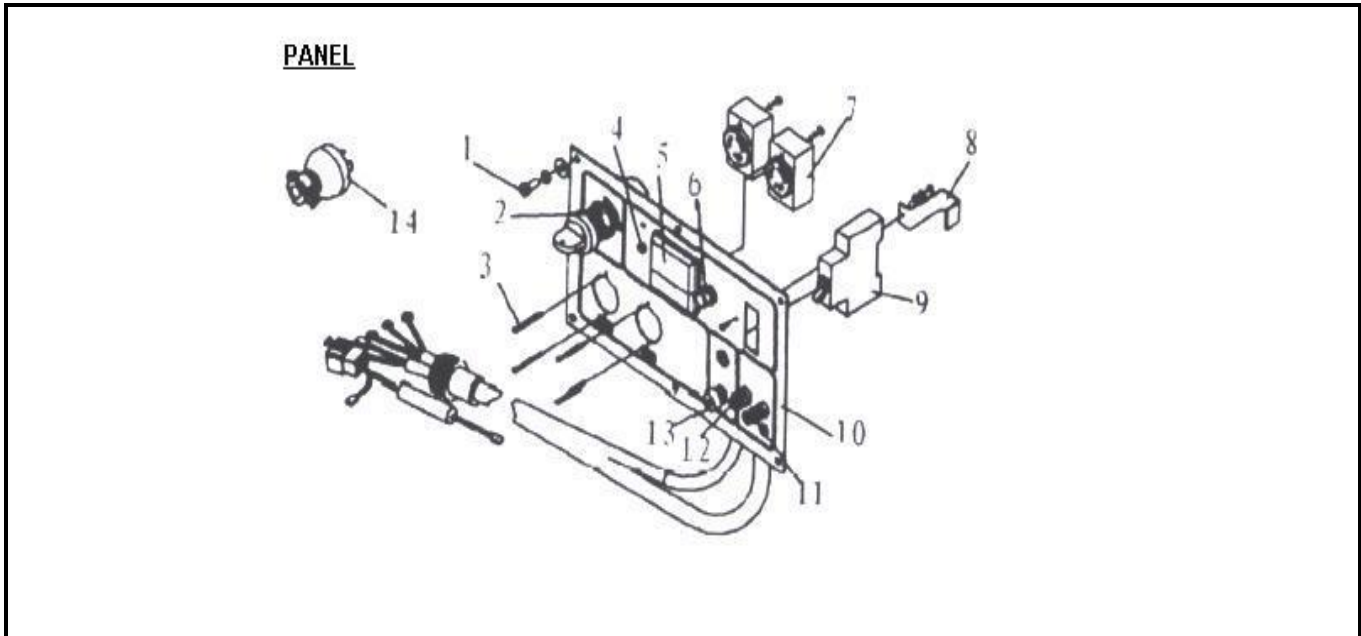

GENERADOR DIESEL 5,5kW 10HP 3600RPM 120/240V

Parte: PANEL

Código 393900

Modelo XDG5500C



N°	Cód. Savake	Descripción Español	Descripción Ingles	Cant.	Observaciones
1			Screw M6x12	6	
2	394403	SWITCHERA P/XDG5500E /XDG5500C	Electric Lock	1	
3			Screw M3x30	4	
4			Oil Pressure Indicator Light	1	
5			AC Voltmeter	1	
6			Fuse	1	
7			Receptacle	2	
8			Air Switch Mount	1	
9	394411	BREACKER P/XDG5500E /XDG5500C	Air Switch	1	
10			Control Panel	1	
11			12V Cathode Wiring Terminal	1	
12			12V Positive Wiring Terminal	1	
13			Generator Wiring Terminal	1	
14			Accumulator	1	



GENERADOR DIESEL CABINADO 5.7 KW 120/240

Parte: ALTERNADOR

Código 393900

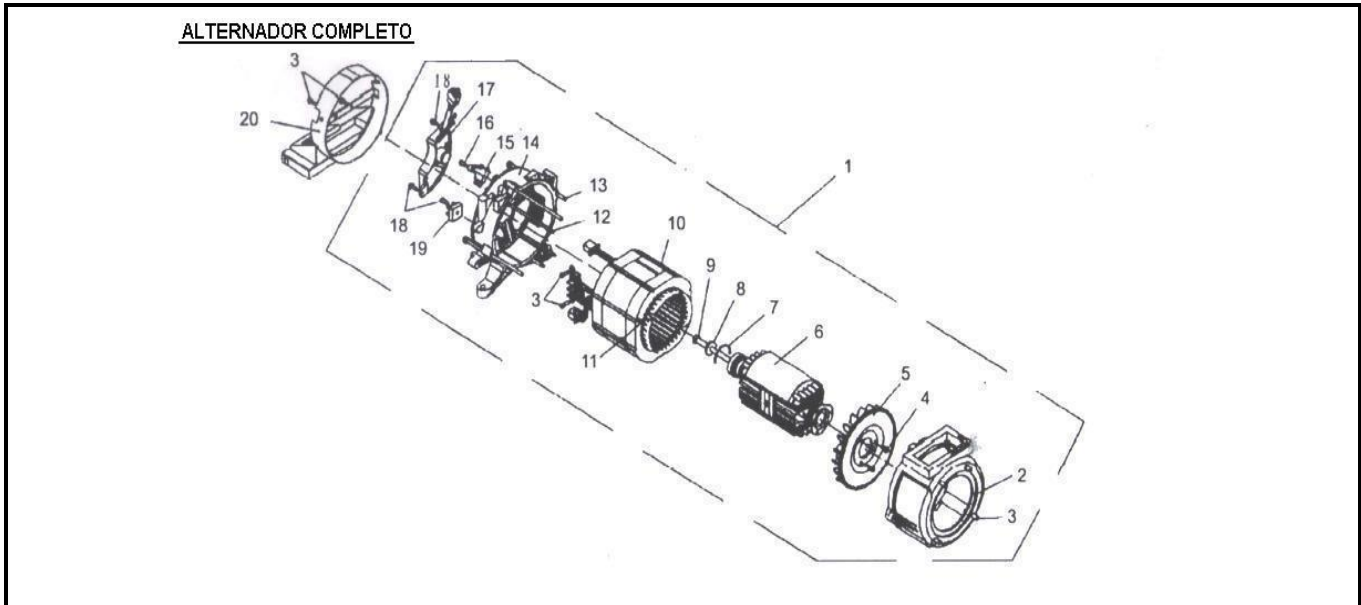
Modelo XDG5500C

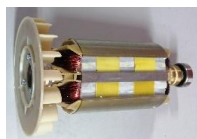



N°	Cód. Savake	Descripción Español	Descripción Ingles	Cant.	Observaciones
1			Electric Machine	1	
2	394262	TAPA DEL ALTERNADOR LADO MOTOR P/XDG5500E /XDG5500C	Front Cover of Electric Machine	1	
3			Hexagonal Bolt M8x30	4	
4			Screw M5x12	7	
5			Fan	1	
6	394296	INDUCIDO P/XDG5500E /XDG5500C	Rotor	1	
7			Clip	1	
8			Gasket	1	
9			Bolt(locking rotor)	1	
10	394304	CAMPO P/XDG5500E /XDG5500C	Stator	1	
11			Round Nut M5	2	
12			Bolt M5 (locking Stator)	2	
13			Bolt M6 (locking front Cover)	4	

GENERADOR DIESEL 5,5kW 10HP 3600RPM 120/240V

Parte: ALTERNADOR

Codigo: 393900

Modelo: XDG5500C

N°	Cód. Savake	Descripción Español	Descripción Ingles	Cant.	Observaciones
14	394346	TAPA DEL ALTERNADOR LADO AVR P/XDG5500E /XDG5500C	Rear Cover of Electric Machine	1	
15	394361	CARBONERA P/XDG5500E /XDG5500C	Carbon Brush	1	
16			Screw M5x16	2	
17	394379	AVR P/XDG5500E /XDG5500C	Exitation AVR	1	
18			Screw M5x16	3	
19			Rectifier	1	
20			Air Cover Of Electric Machine Weldment	1	
	478958	BATERIA P/XDG5500E /XDG5500C	Battery	1	

GENERADOR DIESEL 5,5kW 10HP 3600RPM 120/240V

Parte: MOTOR

Código 393900

Modelo XDG5500C

N°	Cód. Savake	Descripción Español	Descripción Ingles	Cant.	Observaciones
1			Oil seal 35*50*8	1	
2			Stud bolt M6*24	2	
3			Stud bolt M6*24	1	
4			O-ring f19*2.65	1	
5			Dipstick	1	
6			Needle roller bearings HKH0810	2	
7			Oil drain plug	1	
8			Oil drain plug gasket	1	
9	394478	BLOQUE P/MOTOR 10HP (186FA) 418cc	186FA body	1	
10			Stop film	1	
11			Flange bolt M8*14	1	
12			Needle roller bearings HK1512	1	
13			Deep groove ball bearing 6203P	2	
14			Cylinder head bolt (short)	2	
15			Cylinder head positioning pin 4x8	2	
16			Cylinder head nut gasket	4	
17			Cylinder head nut (short)	2	
18			Cylinder head nut (long)	2	
19	394486	EMPACADURA DEL CILINDRO P/MOTOR 10HP (186FA) 418cc	Cylinder head gasket	1	
20			Cylinder head bolt (long)	2	
21			Rectangular seal 186	1	
22			Air deflector 186	1	
23			Flange bolt M6*16	1	
24			Air deflector cushion cover	1	
25			Air deflector cushion	1	
26			Air deflector shock absorber	1	
27			Side cover gasket	1	
28			Deep groove ball bearing 6207P	1	
29	394494	TAPA DEL CARTER P/MOTOR 10HP (186FA) 418cc	Side cover	1	
30			Aluminum plug 8x10	3	
31			Plug G1/8	1	
32			Flange bolt M8*33.5	16	
33			Oil seal 35*50*10	1	
34			Side cover positioning pin f8*12	2	
35			Main bearing	1	
36			Intake pipe gasket	1	
37	394510	VAVULA DE ADMISION Y ESCAPE P/MOTOR 10HP (186FA) 418cc	Intake valve	1	
38			Exhaust valve	1	
39			Stud bolt M8*20	2	
40			Muffler gasket	1	
41			Rocker positioning pin f4*8	1	
42			Nozzle insulation	1	
43			Nozzle pressure plate	1	

GENERADOR DIESEL 5,5kW 10HP 3600RPM 120/240V

Parte: MOTOR

Código 393900

Modelo XDG5500C





N°	Cód. Savake	Descripción Español	Descripción Ingles	Cant.	Observaciones		
44			Flange nut M6	2			
45			Rocker arm assembly	1			
36	394502	CULATA COMPLETA P/MOTOR 10HP (186FA) 418cc	Intake pipe gasket	1			
37			Intake valve	1			
38			Exhaust valve	1			
39			Stud bolt M8*20	2			
46			Rocker bolt M8*50	2			
47			Valve adjustment block	2			
48			Valve lock clip	4			
49			Valve spring seat	2			
50			Valve spring	2			
51			Valve seal	2			
52			Valve spring washer	2			
53			Stud bolt M6*55	2			
54				cylinder head		1	
55				Stud bolt M6*75		2	
56	527846	TAPA VALVULAS P/MOTOR 10HP (186FA) 418cc	Cylinder head cover gasket	1			
57			Cylinder head cover	1			
58			Aluminum block 8*8	1			
59			Pressure reducing spring	1			
60			O-ring f10*1.9	1			
61			Pressure reducing handle	1			
62			Pin 3*16	1			
63			Flange bolt M6*70	3			
64			Respirator	1			
65			O-ring f12*1.9	1			
66		External pressure reducing handle	1				
67		External decompression handle rubber s	2				
68		Pull rod	1				
69		External decompression control handle	1				
70		External decompression handle handle	1				
71		Flange bolt M6*14	3				
72		Flange nut M6	1				
73		External decompression handle bushing	1				
74	394544	ANILLOS DEL PISTON P/MOTOR 10HP (186FA) 418cc	First oil ring	1			
75			Second oil ring	1			
76			Third gas ring	1			
77	394528	PISTON P/MOTOR 10HP (186FA) 418cc	piston	1			
78			Piston pin	1			
79			Hole retaining ring 23	2			
80	394536	BIELA P/MOTOR 10HP (186FA) 418cc	link	1			

GENERADOR DIESEL 5,5kW 10HP 3600RPM 120/240V

Parte: MOTOR

Código 393900

Modelo XDG5500C



N°	Cód. Savake	Descripción Español	Descripción Ingles	Cant.	Observaciones
81	394569	CONCHAS DE BIELA P/MOTOR 10HP (186FA) 418cc	Connecting rod	1	
82	394577	CONTRA PESO CIGÜEÑAL P/MOTOR 10HP (186FA) 418cc	Balance axis	1	
83			Flat key 5*7	2	
84			Balance shaft drive gear	1	
85			Flange bolt	1	
86			Flat pad	1	
87			Crankshaft timing gear	1	
88			Flat key 6*50	1	
89	394585	CIGÜEÑAL P/MOTOR 10HP (186FA) 418cc	Crankshaft	1	
90			Aluminum block 6x8	1	
91			Flat key 5*14	3	
92			Balance shaft gear	1	
93			Bearing 6308P5	1	
94	394643	VOLANTE MAGNETICO CON CREMALLERA P/MOTOR 10HP (186FA) 418cc	flywheel	2	
95			Flywheel nut washer	1	
96			Flywheel nut	1	
97			Starting claw	1	
98			Flange bolt M6*12	4	
99	394650	BALANCIN P/MOTOR 10HP (186FA) 418cc	Valve push rod	2	
100	394668	TAQUETE P/MOTOR 10HP (186FA) 418cc	Valve tappet	2	
101	394676	ARBOL DE LEVA P/MOTOR 10HP (186FA) 418cc	Camshaft	1	
102			Camshaft timing gear	1	

GENERADOR DIESEL 5,5kW 10HP 3600RPM 120/240V

Parte: MOTOR

Código 393900

Modelo XDG5500C

N°	Cód. Savake	Descripción Español	Descripción Ingles	Cant.	Observaciones
143			Oil Cup	1	
144	527887	FILTRO DE COMBUSTIBLE P/XDE10K-I /XDE10TK /XDG5500E /XDG5500C /XDWP3C /XDWP3CT	Diesel filter	1	
145			Diesel filter gasket	1	
146			Oil switch gasket	1	
147			Oil switch	1	
148	527754	LLAVE DE COMBUSTIBLE P/MOTOR 10HP (186FA) 418cc	High-pressure pipeline	1	
149			Oil pipeline	1	
150			Oil pipeline card	2	
151			Hex nut M6	2	
152			Flange bolt M6*14	2	
153			Fuel tank lower bracket	1	
154			Fuel tank rubber block	4	
155			tank	1	
156			Oil return pipe	1	
157			Return pipe clamp	2	
158			Fuel tank upper bracket	1	
159			Flat pad 8	2	
160			Shaped screw 1 bolt		
161			Flange bolt M8*45	1	
162			Fuel injection pump gasket	1	
163	527945	BOMBA DE INYECCION P/MOTOR 10HP (186FA) 418cc	Fuel injection pump	1	
164			Sealing plate gasket	1	
165			sealing board	1	
166			Flange nut M6	3	
167			Air hood seal	1	
168			Wind shield	1	
169			Air dam cushion	4	
170			Windshield cushion cover	4	
171			Flat pad 6	4	
172			Hex bolt M6*25	4	
173			Hand tray	1	
174			Flange bolt M6*8	4	

GENERADOR DIESEL 5,5kW 10HP 3600RPM 120/240V

Parte: MOTOR

Código 393900

Modelo XDG5500C

N°	Cód. Savake	Descripción Español	Descripción Ingles	Cant.	Observaciones
175	394759	INYECTOR P/MOTOR 10HP (186FA) 418cc	Injector	1	
176			Flange bolt M10*20	2	
176-1			Flange bolt M10*30	2	
177			Spring pad 10	2	
178	394460	ARRANQUE ELECTRICO P/XDG5500E /XDG5500C /XDW200E	Starter 0.75KW	1	
178-1			Starter hole plug cover	1	
179	394445	BOBINA EXITADORA P/MOTOR 10HP (186FA) 418cc	Flywheel generator rotor	1	
183			Crimping board	1	
184			Flywheel generator stator	1	
180			Cross countersunk head screw M6*14	3	
181			Flange bolt M6*20	3	
182			Flange bolt M6*12	1	
185			Cross round head screw M6*12	2	
186			Voltage regulator block	1	
187			Flange bolt M6*14	2	
188	394452	REGULADOR DE VOLTAJE P/MOTOR 10HP (186FA) 418cc	Voltage regulator bracket	1	
189			Flywheel ring gear	1	